

VITI

VITI

PER LEGNO
AUTOFILETTANTI per lamiera
materie plastiche
A FILETTO METRICO per metalli

TESTE
tonde cilindriche
esagonali svasate
quadre a goccia

TAGLI
diritti
a croce
a stella (torx)
a brugola (esagono incassato)

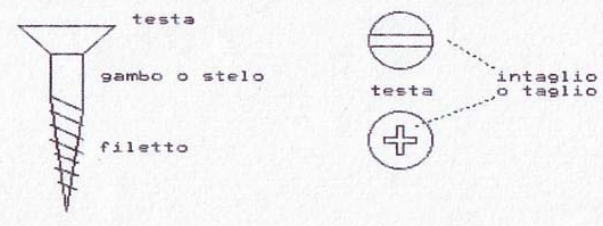

PARTI DI UNA VITE

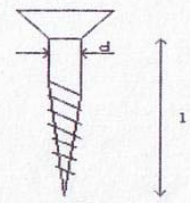

MISURA DELLE VITI PER LEGNO E AUTOFILETTANTI
 $d \times l$ (mm)

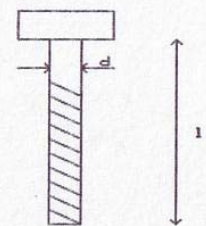

MISURA DELLE VITI A FILETTO METRICO (per metalli)
 $M d \times l$ (mm)

siglatura delle viti a filetto metrico

varie forme di teste di viti

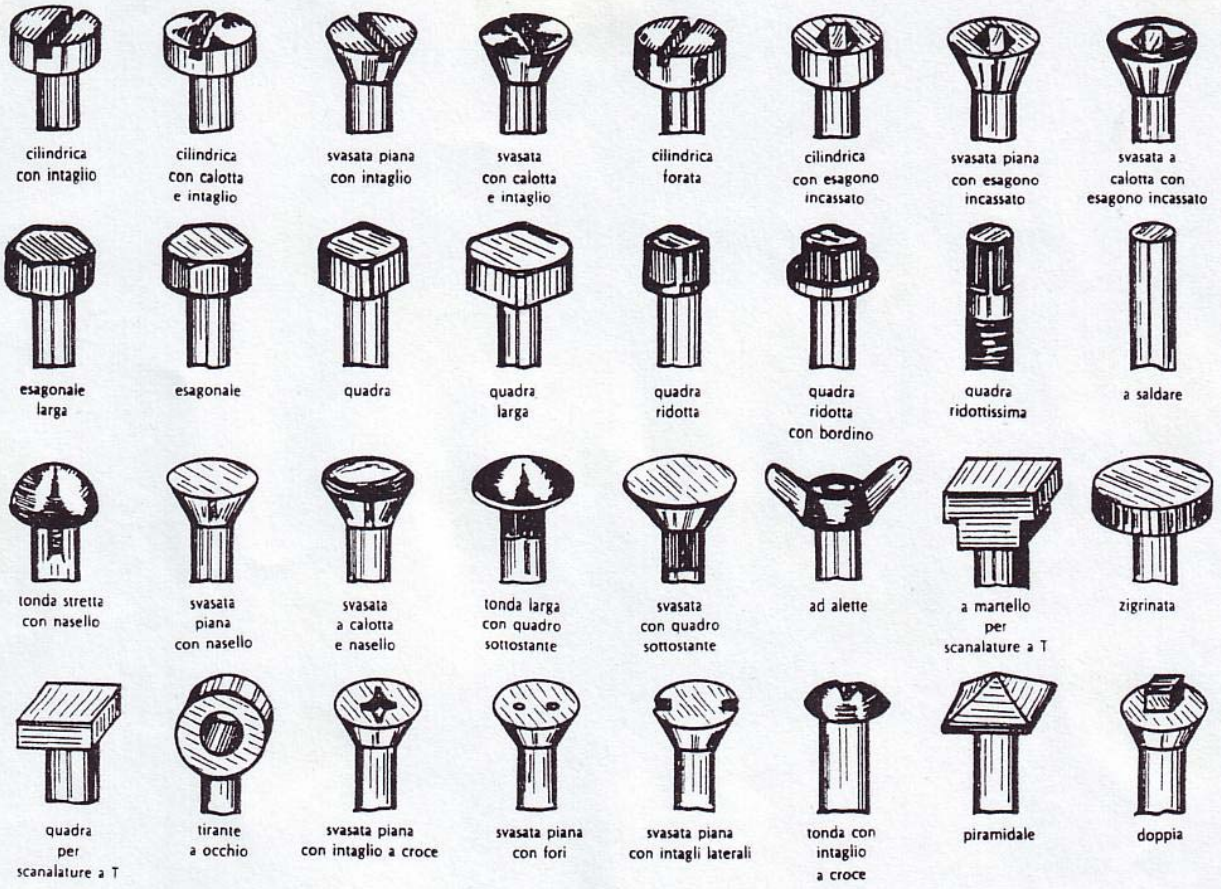

varie forme di estremità di viti

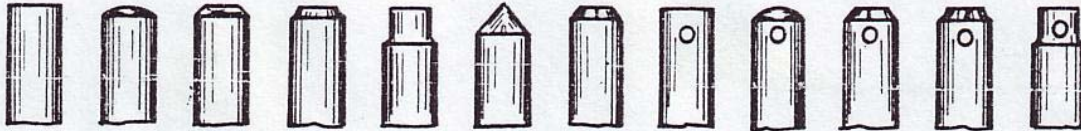

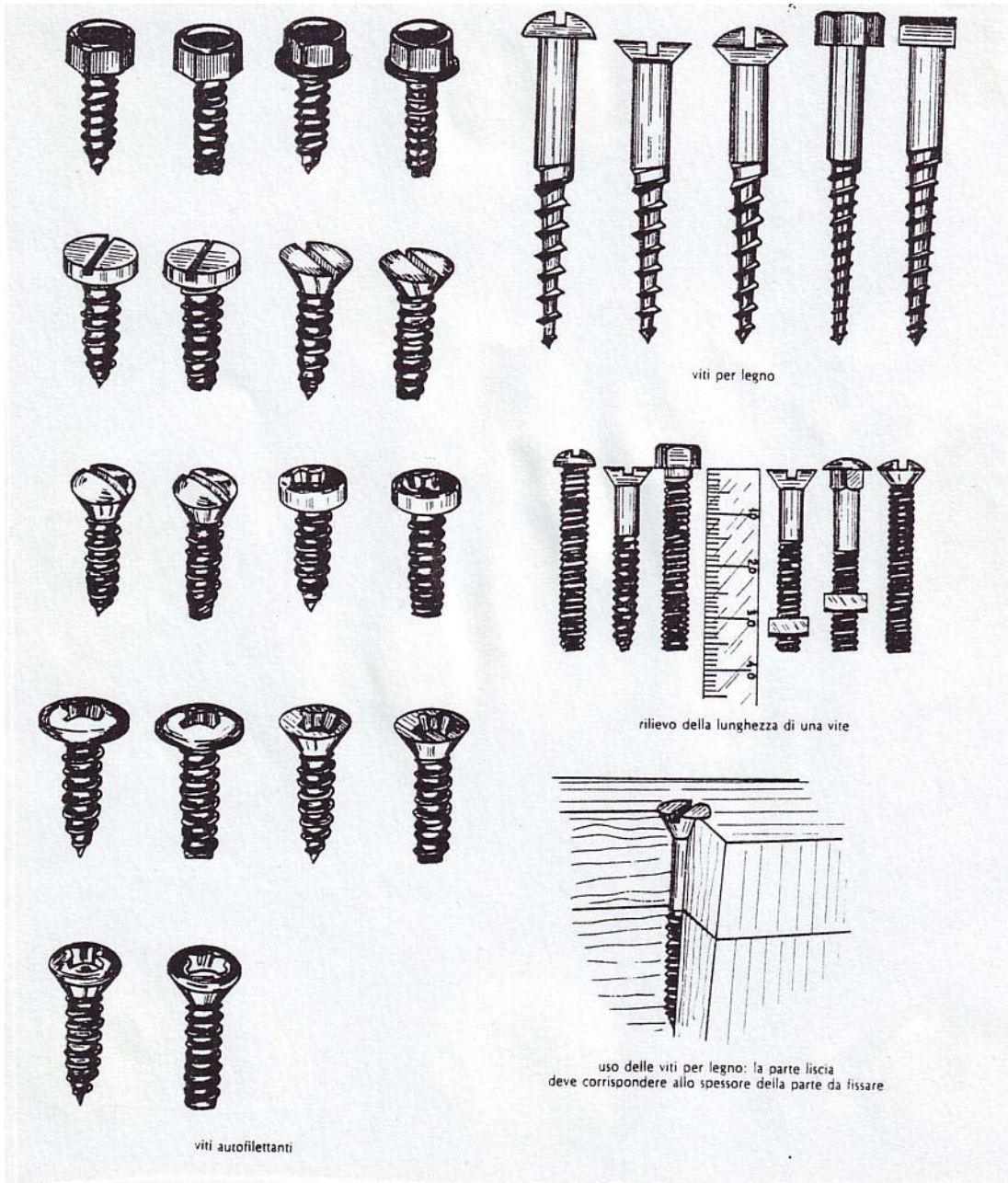

DADI

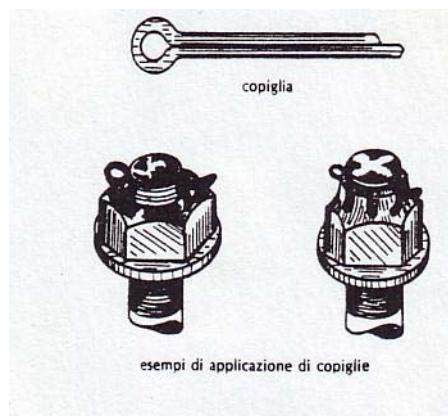

RANELLE O ROSETTE

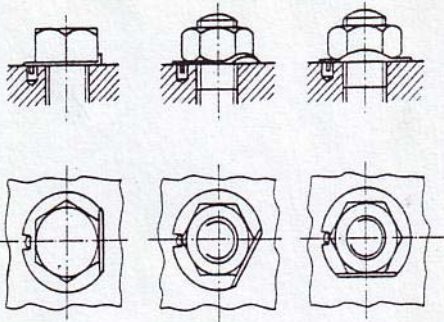

esempi di applicazione della rosetta elastica con nasello

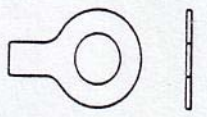

rosetta di sicurezza con linguetta

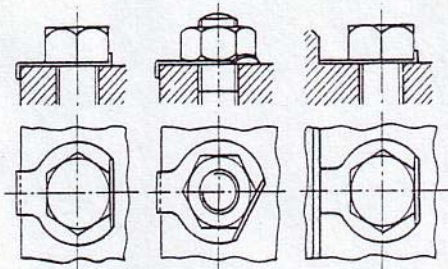

esempi di applicazione della rosetta di sicurezza con linguetta

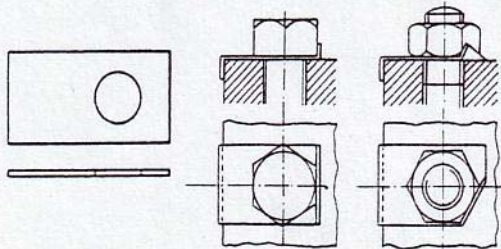

piastrina di sicurezza ed esempi di applicazione

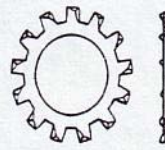

rosetta dentata piana a denti esterni

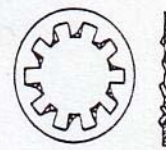

rosetta dentata piana a denti interni

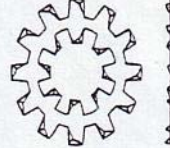

rosetta dentata piana a denti interni ed esterni

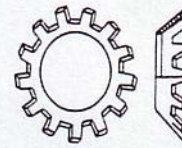

rosetta dentata per viti a testa svasata

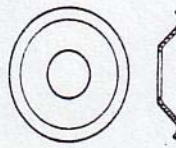

rosette per viti a testa svasata

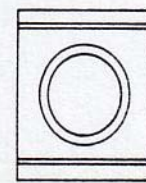
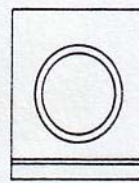
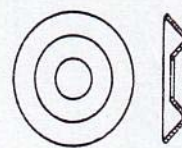

piastrine per appoggio su ali di travi e profilati

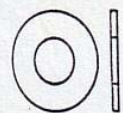

rosetta piana sottile

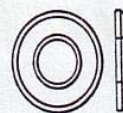

rosetta piana lavorata

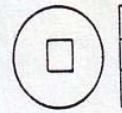

rosetta con foro quadro

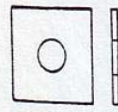

piastrina quadra di appoggio

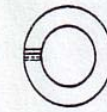

rosetta elastica

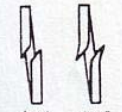

tipo A tipo B

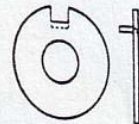

rosetta di sicurezza con nasello

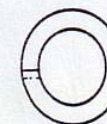

rosetta elastica doppia

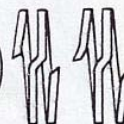

tipo A tipo B

CACCIAVITI

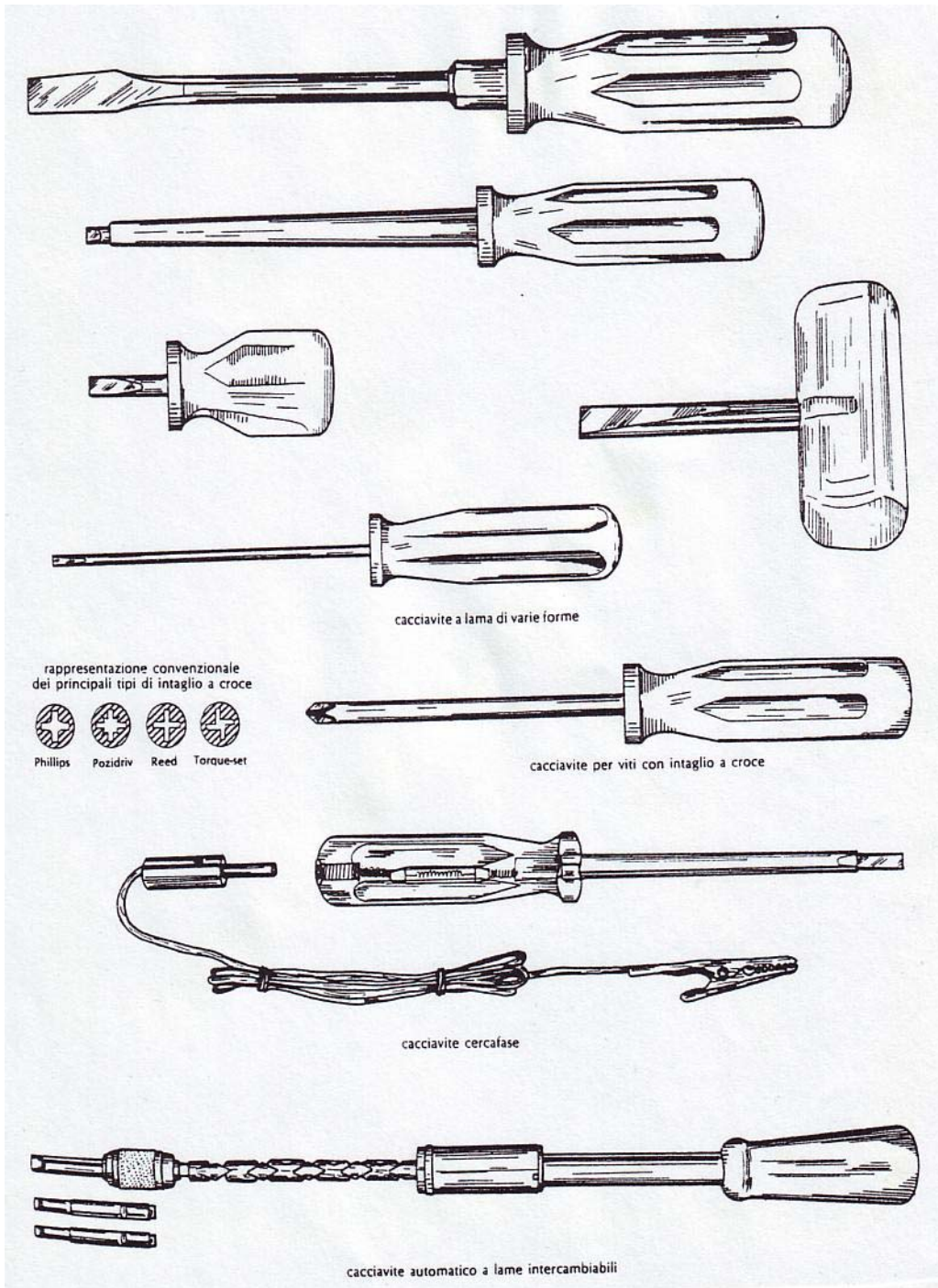

CHIAVI



chiave fissa a due bocche

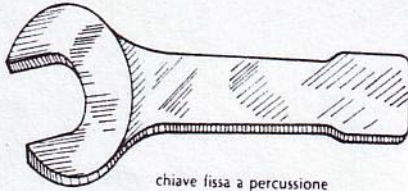

chiave fissa a percussione

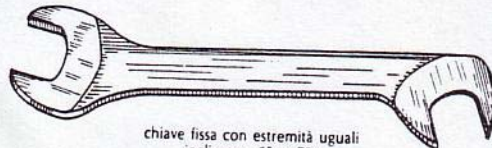

chiave fissa con estremità uguali inclinate a 15° e 75°

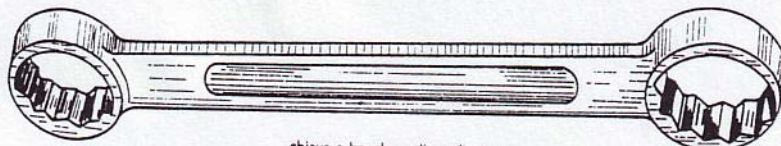

chiave a bocche poligonali piatte

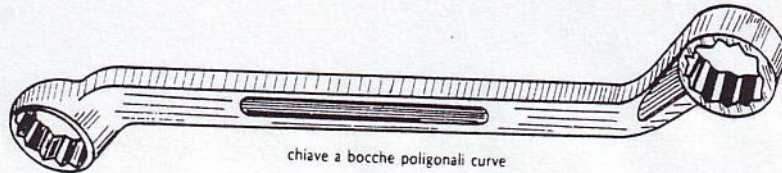

chiave a bocche poligonali curve



si



no

uso corretto delle chiavi regolabili

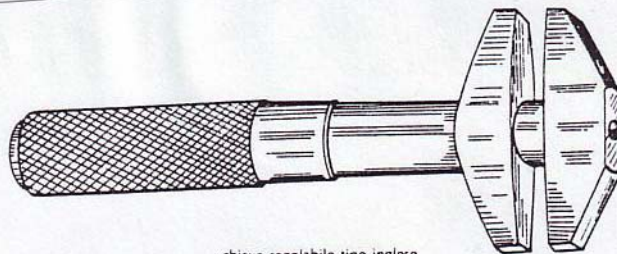

chiave regolabile tipo inglese

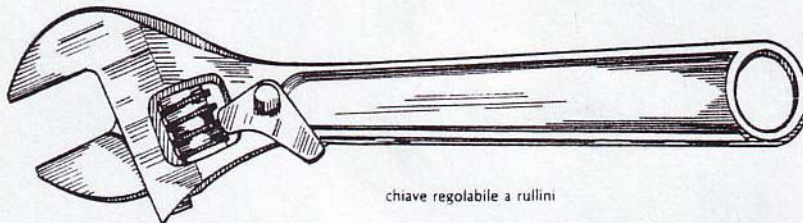

chiave regolabile a rullini

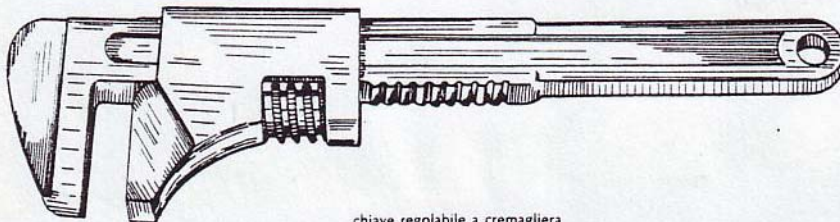

chiave regolabile a cremagliera



chiavi per viti con esagono incassato:
tipo normale e lungo

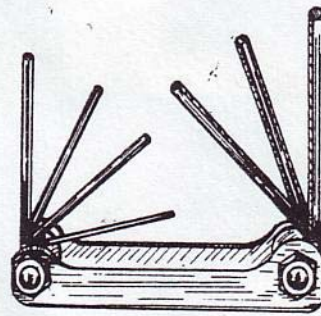

assortimento di chiavi per viti
con esagono incassato



chiave con manico per viti con esagono incassato: tipo diritto

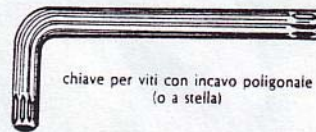

chiave per viti con incavo poligonale
(o a stella)



chiave con manico per viti con esagono incassato:
tipo curvo



chiave con manico per viti con incavo poligonale
(o a stella)



chiave a sfera per viti con esagono incassato

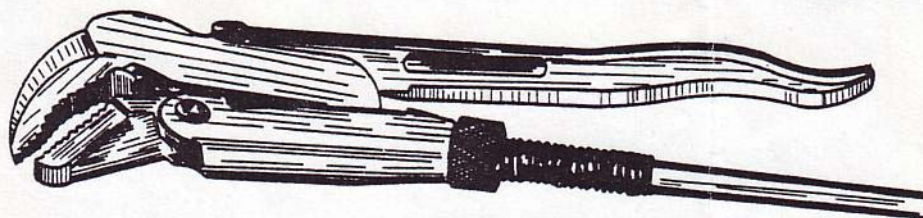

giratubi modello svedese

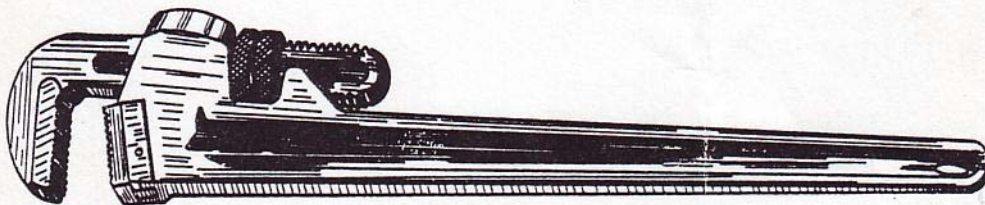

giratubi modello americano